

No-Hub

List Price Schedule NH-119
Effective January 1, 2019
(Updated February 14, 2020)
Supersedes Price Schedule NH-718

Possession of this price list shall not be construed as an offer to sell the products listed.
Charlotte Pipe and "You can't beat the system" are registered trademarks of Charlotte Pipe and Foundry Company.
©1963-2020 Charlotte Pipe and Foundry Company



>> No-Hub (Hubless) Cast Iron Soil Pipe and Fittings

Please contact Customer Service or refer to Excel and HTML price sheets on www.charlottepipe.com for crate and half-crate quantities.

ASTM A 888 & CISPI 301

Size	*UPC# 611942-	Weight	List Price Each	Size	*UPC# 611942-	Weight	List Price Each
------	------------------	--------	--------------------	------	------------------	--------	--------------------



Part No. NH 1 No-Hub (Standard) Coupling

1½	00097	.2	NHC
2x1½	00099	.4	NHC
2	00098	.3	NHC
3x2	00101	.4	NHC
3	00100	.3	NHC
4x3	00103	.8	NHC
4	00102	.7	NHC
5	00104	.9	NHC
6	00105	1.0	NHC
8	00106	1.4	NHC
10	00107	1.7	NHC



Part No. SDC 4 Heavy Duty (HD) Coupling

1½	11512	.5	SDC
2	11513	.6	SDC
3	11514	.7	SDC
4	11515	.9	SDC
5	11516	1.5	SDC
6	11517	1.7	SDC
8	11518	2.1	SDC
10	11519	2.5	SDC



Part No. HD 1 Heavy Duty Coupling

12	09632	2.3	SDC
15	09633	2.7	SDC



Part No. MDC 2 Heavy Duty (MD) Coupling

1½	13907	.4	MDC
2	13908	.4	MDC
3	13909	.6	MDC
4	13910	.7	MDC
5	13911	1.2	MDC
6	13912	1.4	MDC
8	13913	1.5	MDC
10	13914	1.9	MDC

Part No. NH 2 No-Hub Pipe

Size	UPC#	Weight	List Price
1½"x10'	00128	28.5	\$138.30
2"x10'	00129	35.0	138.70
3"x10'	00130	54.0	191.40
4"x10'	00131	76.0	248.50
5"x10'	00132	97.6	358.10
6"x10'	00133	117.8	427.10
8"x10'	00134	170.9	665.50
10"x10'	00135	254.6	1130.60
12"x10'	09606	318.0	1642.50
15"x10'	09607	492.6	2400.20

NHC > Please see list price in No-Hub (Standard) Couplings price sheet.
MDC > Please see list price in Heavy Duty (MD) Couplings price sheet.
SDC > Please see list price in Heavy Duty (HD) Couplings price sheet.

See page 15 for pipe bundle quantities.

Charlotte Pipe® products are manufactured to the applicable ASTM standard. Charlotte Pipe and Foundry cannot accept responsibility for the performance, dimensional accuracy, or compatibility of pipe, fittings, gaskets, or couplings not manufactured or sold by Charlotte Pipe and Foundry.

Charlotte Pipe and Foundry Company strongly recommends that its cast iron pipe and fittings be joined with shielded hubless couplings manufactured in accordance with CISPI 310 or ASTM C 1540. Failures in installations using couplings not recommended by Charlotte Pipe® are not the responsibility of this Company.

You can't beat the system.®

Size	*UPC# 611942-	Weight	List Price Each	Size	*UPC# 611942-	Weight	List Price Each
	Part No. NH 4 Quarter Bend				Part No. NH 8B Extended Quarter Bend with Low Heel Inlet		
1½	00136	1.7	\$18.80	3x2	12024	7.8	\$80.20 N
2	00137	2.2	20.40		Part No. NH 9 Fifth Bend		
3	00141	3.7	28.50	2	12025	2.3	\$27.30 N
4	00146	6.5	42.20	3	12026	3.7	47.10 N
5	00148	9.3	95.00	4	00165	6.1	73.80
6	00149	15.0	102.10		Part No. NH 10 Sixth Bend		
8	00150	23.1	287.00	2	00166	2.2	\$21.60
4x3 <small>Reducing Increasing</small>	00147	5.5	85.80	3	00167	3.0	27.80
	Part No. NH 4 Extended Quarter Bend			4	00168	5.3	37.20
2x12	00138	5.4	\$57.60		Part No. NH 12 Eighth Bend		
2x18	00139	8.8	85.70	1½	00169	1.5	\$15.70
2x24	00140	10.7	116.50	2	00170	1.5	17.60
3x12	00142	8.5	97.80	3	00173	2.9	23.60
4x12	00144	11.2	144.90	4	00176	4.0	30.90
	Part No. NH 4A Tapped Quarter Bend			5	00178	7.4	64.50
1½x1½	00152	1.9	\$25.50	6	00179	9.1	68.50
2x1¼	00153	2.0	26.70	8	00180	14.9	197.70
2x1½	00154	1.8	23.70	10	00181	31.7	375.80
2x2	00155	2.9	34.80	12	09608	31.6	759.70
	Part No. NH 6 Quarter Bend with 2" Side Inlet			15	09609	62.0	1515.50
3	00156	5.1	\$57.80	2x6 Long	12104	2.4	53.90 N
4	00157	7.5	94.50	2x12 Long	00171	4.6	55.10
	Part No. NH 8 Quarter Bend with 2" Heel Inlet			2x18 Long	00172	7.3	79.50
3	00158	5.6	\$45.20	3x12 Long	00174	8.0	84.40
4	00159	7.2	57.60	3x18 Long	00175	10.2	133.20
	Part No. NH 8A Double Quarter Bend			4x12 Long	00177	9.7	136.70
2	00160	4.5	\$46.20		Part No. NH 14 Sixteenth Bend		
3	00161	7.1	74.20	1½	00182	1.2	\$16.50
4	00162	9.7	97.70	2	00183	1.4	18.00
				3	00184	2.1	21.00
				4	00185	3.4	27.70
				5	00186	5.4	61.30
				6	00187	6.7	74.20
				8	00188	12.0	118.10

N = Non-stock item; Contact customer service for availability.

Size	*UPC# 611942-	Weight	List Price Each	Size	*UPC# 611942-	Weight	List Price Each
------	------------------	--------	--------------------	------	------------------	--------	--------------------



**Part No. NH 16
Short Sweep**

2	00189	3.1	\$28.40
3	00190	6.3	37.20
4	00191	8.1	65.90
5	00192	13.1	115.60
6	00193	17.1	121.50
8	00194	31.0	314.50
10	00195	53.4	573.70
12	09621	61.3	1791.70
15	09622	105.6	2346.90



**Part No. EZS 14
Extended Short Sweep**

2x18	04448	8.0	\$120.00
2x24	04444	11.0	132.10
2x34	04449	13.9	223.10



**Part No. NH 18
Long Sweep**

1½	00198	4.4	\$47.80
2	00199	5.8	44.70
3	00201	9.4	54.10
4	00203	12.3	86.00
5	00204	18.6	155.60
6	00205	23.3	190.10
4x3	Reducing Increasing 00202	12.4	167.10



**Part No. NH 20
Wye**

1½	00207	2.5	\$26.70
2	00208	3.3	26.10
3x1½	00215	4.4	33.90
3x2	00216	3.4	28.20
3	00209	4.6	38.00
4x2	00217	5.1	40.40
4x3	00218	7.3	52.80
4	00210	9.1	60.80
5x2	00220	8.8	89.40
5x3	00221	10.5	125.50
5x4	00219	13.1	129.10
5	00211	15.1	144.20
6x2	00225	9.8	99.50
6x3	00224	12.5	125.50
6x4	00223	14.6	129.10
6x5	00222	17.6	156.70
6	00212	19.7	161.90
8x3	00227	17.5	202.60
8x4	00228	22.0	222.00
8x5	00229	23.9	269.00
8x6	00230	28.3	273.10
8	00213	36.3	381.10
10x4	00231	32.9	586.60
10x6	00232	42.1	614.00
10x8	00233	56.1	736.80
10	00214	74.9	845.90
12	09619	97.0	1666.00
15	09620	189.5	3875.10



**Part No. NH 21
Double Wye**







2	00234	4.5	\$41.40
3x2	00241	5.5	64.50
3	00235	7.9	76.40
4x2	00242	6.5	85.80
4x3	00243	8.8	96.90
4	00236	12.1	155.20
5x4	00244	15.7	206.00
6x4	00245	16.4	221.40
6	00237	27.4	274.10
8	00238	45.3	781.70
8x4	00246	23.0	378.60
8x6	00247	31.3	532.00









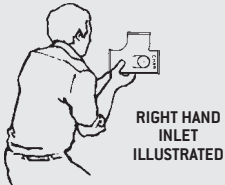



WARNING









Testing with or use of compressed air or gas in Cast Iron pipe or fittings can result in explosive failures and cause severe injury or death.

AIR/GAS

- NEVER test with or transport/store compressed air or gas in Cast Iron pipe or fittings.
- NEVER test Cast Iron pipe or fittings with compressed air or gas.
- ONLY use Cast Iron pipe and fittings for drain, waste and vent or sanitary sewer applications.

Size	*UPC# 611942-	Weight	List Price Each	Size	*UPC# 611942-	Weight	List Price Each
	Part No. NH 21A Upright Wye				Part No. NH 24 Double Combination		
2	00248	4.8	\$45.80	2	00284	6.3	\$70.90
3x2	00251	5.7	44.80	3x2	00287	7.7	92.80
3	00249	9.5	62.60	3	00285	11.8	109.20
4x2	00252	7.7	63.00	4x2	00290	8.3	135.50
4x3	00253	10.1	83.80	4x3	00291	13.7	142.10
4	00250	12.9	165.80	4	00286	20.5	214.40
5x2	04428	11.0	272.30		Part No. NH 26 Tapped Wye		
5	04740	19.9	300.80	2x1½	00295	3.4	\$59.00
	Part No. NH 22 Combination Wye and Eighth Bend			2x2	04421	4.6	63.80
1½	00260	3.1	\$28.40	3x1½	00296	5.1	66.30
2x1½	00267	3.4	31.60	3x2	00297	5.3	75.00
2	00261	3.5	29.70	4x1½	00298	6.0	74.20
3x1½	00268	5.0	49.50	4x2	00299	7.2	82.00
3x2	00269	5.7	37.20		Part No. NH 27 Tapped Double Wye		
3	00262	8.5	46.90	2x1½	00300	5.6	\$117.20
4x2	00271	6.6	48.50		Part No. NH 28 Sanitary Tee		
4x3	00272	9.5	69.10	1½	00301	2.9	\$26.30
4	00263	13.7	90.30	2x1½	00308	3.4	28.50
5x2	00273	8.5	121.10	2	00302	3.1	28.20
5x3	00274	12.0	154.20	3x1½	00309	4.5	33.40
5x4	00275	17.1	170.30	3x2	00310	3.7	30.80
5	00264	19.7	184.80	3	00303	5.5	34.80
6x2	00276	12.0	125.50	4x2	00312	5.3	44.20
6x3	00277	14.7	152.20	4x3	00313	7.6	50.70
6x4	00278	18.4	145.70	4	00304	8.5	65.80
6x5	00279	23.4	198.90	5x2	00314	8.3	110.10
6	00265	30.0	247.90	5x3	00315	10.2	115.60
8x4	00280	25.1	302.20	5x4	00316	11.5	119.00
8x6	00281	35.4	451.90	5	00305	12.5	153.90
8	00266	49.3	579.90	6x2	00317	9.9	113.70
	Part No. EZS 15 Extended Combination			6x3	00318	11.5	115.60
2x24	04453	12.0	\$149.10	6x4	00319	12.0	119.00
2x36	04450	15.4	250.60	6x5	00320	15.6	186.80
How To Determine Right Or Left Hand Inlets:				6	00306	12.9	156.90
For All Branch Fittings.				8x3	00321	17.9	326.90
Place the spigot near you with the branch facing upward.				8x4	00322	21.6	335.50
				8x5	00323	24.0	378.60
				8x6	00324	24.0	366.90
				8	00307	30.8	636.30

Size	*UPC# 611942-	Weight	List Price Each	Size	*UPC# 611942-	Weight	List Price Each	
	Part No. EZS 16 Two-Way Sanitary Tee				Part No. NH 33A Sanitary Cross (New Orleans Code, with 2" 90° Sanitary Inlet Above Center)			
2x18	04872	7.8	\$104.00	4	00382	10.8	\$205.90	
2x24	04451	10.4	125.00					
2x36	14095	15.6	143.30					
	Part No. NH 30 Sanitary Cross				Part No. NH 33C Sanitary Cross (New Orleans Code, with 2" 90° Sanitary Inlets Right and Left Above Center)			
1½	00326	3.6	\$39.80	3 w/2RH & LH	00385	9.0	\$190.10	
2	00327	5.0	48.10	4 w/2 RH & LH	00386	11.9	239.00	
3x2	00332	6.2	66.20					
3	00328	7.6	74.10		Part No. NH 33F Sanitary Cross (New Orleans Code, with Two 2" 45° Sanitary Inlets Same Side)			
4x2	00334	7.3	94.40		3	00389	9.8	\$259.60
4x3	00335	8.5	114.00	4	00390	13.8	336.10	
4	00329	11.0	140.30					
5x4	00336	13.4	202.60		Part No. NH 33G Sanitary Cross (with 3" Vent and Two 2" 45° Inlets)			
6x4	00338	14.0	202.60		4x3x4x2x2	00391	20.3	\$500.70
6	00330	21.0	296.40					
8x4	00339	23.0	474.90		Part No. NH 34 Sanitary Tapped Tee			
8	00331	37.9	684.70	1½x1¼	00402	2.3	\$36.60	
	Part No. NH 31 Sanitary Tee (New Orleans Code, with 2" 90° Sanitary Inlet Above Center)			1½x1½	00403	2.5	34.80	
3x3 w/LH	00341	6.7	\$119.70	2x1¼	00404	2.8	34.80	
3x3 w/RH	00342	6.3	119.70	2x1½	00405	3.1	30.80	
4x4 w/LH	00345	8.6	162.40	2x2	00407	3.8	35.40	
4x4 w/RH	00344	8.5	162.40	3x1¼	00408	3.7	42.00	
	Part No. NH 32 Sanitary Tee (with 2" Right and Left Side Inlets)			3x1½	00409	3.6	42.00	
4x4 w/RH & LH	00358	10.9	\$205.80	3x2	00412	4.9	49.20	
	Part No. NH 32B Sanitary Tee (New Orleans Code, with 2" 45° Sanitary Inlet Above Center)			3x3	00413	7.3	90.80	
3 w/2 LH	00362	8.2	\$184.20	4x1¼	00414	4.0	54.30	
3 w/2 RH	00363	7.8	184.20	4x1½	00415	4.8	43.60	
3 w/2 RH & LH	00366	9.1	345.50	4x2	00417	5.8	49.50	
4 w/2 LH	00365	9.6	272.50	4x3	00419	8.4	81.00	
4 w/2 RH	00364	9.4	272.50	5x1½	00420	6.5	103.00	
				5x2	00421	9.3	115.60	
				6x1½	00422	8.4	113.70	
				6x2	00423	9.2	120.30	

Size	*UPC# 611942-	Weight	List Price Each	Size	*UPC# 611942-	Weight	List Price Each
	Part No. EZS 17 2" x 22⁷/₈" Extended Tapped Sanitary Tee				Part No. NH 35B Double Vertical Sanitary Tapped Tee		
2x1½	04454	9.6	\$105.60	2x1½	00441	4.8	\$69.00
2x2	04455	9.2	105.60		Part No. NH 36 Test Tee <u>Less Brass Plug</u>		
	Part No. EZS 27 Sanitary Tapped Tee			IPS TAP			
2x1½x31	04460	12.6	\$238.30	2	00443	3.0	\$25.50
2x2x31	04462	13.6	238.30	3	00444	5.8	41.90
	Part No. NH 35 Sanitary Tapped Cross			4	00445	9.2	73.60
1½x1½	00426	3.4	\$43.80	5	00446	15.2	151.30
2x1¼	00427	3.9	47.10	6	00447	22.0	160.90
2x1½	00428	4.0	43.00	8	00448	37.1	410.90
2x2	00429	5.3	50.90	10	00449	59.7	767.40
3x1½	00431	4.3	58.10		Part No. NH 36 S Test Tee with Southern Raised-Head Brass Plug Installed		
3x2	00432	6.1	65.80	IPS TAP			
4x1½	00434	5.5	72.70	2	00473	3.3	\$47.50
4x2	00435	6.9	93.00	3	00474	6.3	79.50
	Part No. EZS 18 2" x 22⁷/₈" Extended Tapped Sanitary Cross			4	00475	10.1	134.90
2x1½	04456	10.0	\$115.60	5	00476	16.4	247.90
2x2	04457	11.9	115.60	6	00477	24.4	362.40
	Part No. EZS 28 Sanitary Tapped Cross			8	04158	40.6	691.50
2x1½x31	04464	15.0	\$238.30		Part No. NH 40 Increaser-Reducer		
2x2x31	04466	15.0	238.30	2x3	00491	3.8	\$34.00
				2x4	00492	4.4	58.30
				3x4	00493	5.0	45.70

Test Tee with plugs installed can be ordered only as shown in the catalog. When ordering Test Tees with plugs other than Southern Code, please order the fitting less plug, then order the plug from the Plugs price sheet, page one.







Example:

<u>Part No.</u>	<u>Quantity</u>	<u>Description</u>
NH 36	4	4" Test Tee
PLG 410	4	4" Ohio Plug

When Test Tees with plugs other than Southern Code are ordered, the plugs will be packed separately in a burlap bag inside shipping crate.

Size	*UPC# 611942-	Weight	List Price Each	Size	*UPC# 611942-	Weight	List Price Each
	Part No. NH 40A Short Reducer				Part No. NH 42B P Trap with 1/2" Tap in Heel		
2x1½	00494	1.1	\$14.80	6	13917	33.6	\$451.40 N
3x1½	00495	1.8	23.80		Part No. NH 43 P Trap with 1/2" Tap in Heel		
3x2	00496	1.8	14.60	2	00531	4.7	\$67.50
4x2	00497	2.3	22.20	3	00532	10.8	107.00
4x3	00498	2.3	22.20	4	00533	18.8	187.70
5x2	00499	3.3	40.70		Part No. EZS 9 P Trap with 1 1/2" Tapped Side Inlet		
5x3	00500	3.8	41.40	2 LH	04446	6.2	\$68.40
5x4	00501	3.2	43.00	2 RH	04445	6.2	68.40
6x2	00502	4.3	61.30		Part No. EZS 10 P Trap with 2" No-Hub Side Inlet		
6x3	00503	3.7	59.90	2 LH	10883	6.4	\$78.70
6x4	00504	4.1	59.90	2 RH	10882	6.4	78.70
6x5	00505	4.3	61.30		Part No. NH 44 P Trap with Tapped Inlet		
8x2	00506	7.0	94.90	1½x1½	00537	3.0	\$57.70 N
8x3	00507	7.6	87.80	2x1½	00538	4.5	61.70
8x4	00508	7.7	92.30	2x2	00540	5.4	68.20
8x5	00509	7.3	104.30		Part No. NH 44A Deep Seal P Trap		
8x6	00510	8.0	102.80	2	00541	6.6	\$69.70
10x4	00511	12.5	181.50	3	00542	11.0	112.30
10x6	00512	13.3	191.90	4	00543	18.6	178.50
10x8	00513	14.9	225.00		Part No. NH 45 Running Trap with Vent		
12x4	09610	19.1	375.60	4	00545	20.5	\$195.70
12x6	09611	18.3	402.40				
12x8	09612	17.3	413.80				
12x10	09613	18.9	420.80				
15x4	09614	30.0	785.70				
15x6	09615	31.8	741.70				
15x8	09616	32.2	853.60				
15x10	09617	32.2	884.50				
15x12	09618	30.5	895.10				
	Part No. NH 42 P Trap						
1½	00514	3.4	\$31.60				
2	00515	4.7	29.70				
3	00516	8.9	65.20				
4	00517	17.0	115.60				
6	00518	33.6	280.50				
2x12 Long	00519	6.1	79.70				
2x18 Long	00520	8.0	99.50				
	Part No. NH 42A P Trap, Reducing						
3x2	12030	10.0	\$144.30 N				

N = Non-stock item; Contact customer service for availability.

Size	*UPC# 611942-	Weight	List Price Each	Size	*UPC# 611942-	Weight	List Price Each
	Part No. NH 45A Running Trap with Double Vent						
4	00546	21.4	\$247.10				
	Part No. EZS 13 45° Vented Tub Wye						
2	04447	10.1	\$131.10				
	Part No. EZS 38 Vented Tub Wye						
2x15	04467	9.4	\$131.00				
2x29½	04474	13.7	215.20				
	Part No. EZS 38 L Vented Tub Wye (Left Hand)						
2	04469	10.0	\$136.00				
	Part No. EZS 38 R Vented Tub Wye (Right Hand)						
2	04468	9.0	\$136.00				
	Part No. NH 48 Tapped Adapters						
1½x1½	00554	1.3	\$22.70				
2x1¼	00555	1.0	30.40				
2x1½	00556	.9	23.50				
2x2	00557	1.7	23.50				
3x2	00560	1.0	22.50				
	Part No. NH 50 Blind Plug						
1½	00561	.6	\$10.20				
2	00562	.7	10.20				
3	00563	1.1	14.80				
4	00564	2.0	23.40				
5	00565	2.9	43.00				
6	00566	3.2	44.80				
8	00567	6.5	119.20				
10	00568	14.7	175.80				
12	09623	17.6	278.40				
15	09624	28.0	478.10				

Tapped Ferrule with plugs installed can be ordered only as shown in the catalog. When ordering Tapped Ferrules with plugs other than Southern Code, please order the fitting less plug, then order the plug from the Plugs price sheet.

Example:

Part No.	Quantity	Description
NH 52	4	4" Tapped Ferrule
PLG 410	4	3½" Ohio Plug

When Tapped Ferrule with plugs other than Southern Code are ordered, the plugs will be packed separately in a burlap bag inside the shipping crate.

Size	*UPC# 611942-	Weight	List Price Each
	Part No. NH 52 Tapped Ferrule <u>Less Brass Plug</u>		
2	00570	0.9	\$19.30
3	00571	1.9	22.00
4	00572	2.5	24.50
5	00573	6.5	58.00
6	00574	8.0	54.80
8	00575	11.7	132.10

Size	*UPC# 611942-	Weight	List Price Each
	Part No. NH 52 S Tapped Ferrule with Southern Raised-Head Brass Plug Installed		
2	00597	1.1	\$41.40
3	00598	2.3	52.80
4	00599	3.2	72.60
5	00600	7.1	114.00
6	00601	9.4	151.60
8	00602	13.9	333.60

Size	*UPC# 611942-	Weight	List Price Each
	Part No. NH 53 Single Two-Way Cleanout		
4	00617	16.0	\$208.60

Size	*UPC# 611942-	Weight	List Price Each
	Part No. NH 53A Double Two-Way Cleanout		
4	00618	15.0	\$191.00

Size	*UPC# 611942-	Weight	List Price Each
	Part No. NH 54 Two-Way Baffle Cleanout		
3x3x4	12032	14.2	\$265.50 N
4x4x4	12033	22.0	265.50

N = Non-stock item; Contact customer service for availability.

Size	*UPC# 611942-	Weight	List Price Each	Size	*UPC# 611942-	Weight	List Price Each
------	------------------	--------	--------------------	------	------------------	--------	--------------------



Part No. NH 56
Notched and Slotted Closet Collar

Connects To

4x3x3½	3" Pipe	00620	3.4	\$42.10
4x3x8	3" Pipe	04777	6.1	92.20
4x4x4	4" Pipe	04762	4.9	49.20
4x4x8	4" Pipe	00621	6.9	118.50



Part No. NH 57
Horizontal Twin Tapped Tee

3x1½		00622	7.3	\$116.90
4x1½		00623	8.0	118.10



Part No. NH 457
Vented Closet Tee with 2" Top Vent
(Left Hand or Right Hand; Designed for use below the floor; Fitting does not require a baffle.)

Illustration Shows Left Hand

4x4x2x4 LH		00626	12.1	\$163.90
4x4x2x4 RH		00625	11.6	163.90



Part No. NH 458
Vented Closet Tee with 2" Top Vent and 2" Side Inlet
(Left Hand or Right Hand; Designed for use below the floor; Fitting does not require a baffle.)

Illustration Shows Left Hand

4x4x2x2x4 LH		00628	12.3	\$195.30
4x4x2x2x4 RH		00627	12.2	195.30



Part No. NH 463
Vented Closet Cross with Top Vent
(Designed for use below the floor; Fitting has a baffle.)

Gray Area Indicates A Baffle

4x4x2x4x4		00631	15.0	\$230.40
-----------	--	-------	------	-----------------



Part No. NH 464
Vented Closet Cross with 2" Top Vent and 2" Side Inlet
(Designed for use below the floor; Fitting has a baffle.)

Gray Area Indicates A Baffle

4x4x2x2x4x4		00633	15.6	\$263.20
-------------	--	-------	------	-----------------



Part No. NH 502
No-Hub Prison Fitting with 2" Top Vent with or without 2" 45° Tap
(Designed for use above the floor; Baffle helps prevent passage of contraband between cells; 12" Laying Length)

4	Less Tap	00639	20.3	\$576.30
4	With Tap	00640	20.8	603.50
4x3	Less Tap	11119	23.4	715.60
4x3	With Tap	11120	23.4	749.40

Part No. EZS 50*
10" Closet Fitting with 2" Inlet

(Double, Left Hand or Right Hand; Designed for use below the floor; Fitting does not have a baffle.)

FLOOR / CEILING



4	EZS 50D**	04484	15.0	\$287.10
4	EZS 50L	04476	12.3	202.80
4	EZS 50R	04477	12.2	202.80

Part No. EZS 51*
10" Closet Fitting with 2" Inlet and 2" Side Inlet

(Double, Left Hand or Right Hand; Designed for use below the floor; Fitting does not have a baffle.)

FLOOR / CEILING



4	EZS 51D**	04424	15.0	\$326.60
4	EZS 51L	04425	12.8	242.40
4	EZS 51R	04473	12.6	242.40

*When ordering please specify Double, Left or Right.

**Double closet fitting does not have a baffle.

Size	*UPC# 611942-	Weight	List Price Each	Size	*UPC# 611942-	Weight	List Price Each
------	------------------	--------	--------------------	------	------------------	--------	--------------------

For use with EZS50 thru 800 Series fittings.
Specify Plain, Double, Left or Right

Note: Our crossovers are designed for use with EZS starter fittings, that is for the vent and stack centerline to be 6½"



Part No. EZS 7
2" Vent Cross-Over Plain
(No Inlets)

2x18¾	04429	8.1	\$79.70
-------	-------	-----	----------------



Part No. EZS 7D
2" Vent Cross-Over Double
(2 Inlets)

2x18¾	04430	8.0	\$100.20
-------	-------	-----	-----------------



Part No. EZS 7L
2" Vent Cross-Over
Left Hand Inlet

2x18¾	04431	8.2	\$79.70
-------	-------	-----	----------------



Part No. EZS 7R
2" Vent Cross-Over
Right Hand Inlet

2x18¾	04432	8.4	\$79.70
-------	-------	-----	----------------

How To Determine Right Or Left Hand Fitting

With the vented end toward you, hold the fitting so that you are looking into its length with the curved side up. If the vent is on your left side, it is a Left hand fitting. If the vent is on your right side, it is a Right hand fitting.

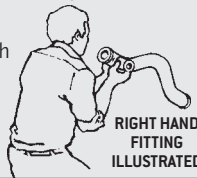

Part No. EZS 1
Figure One

2x1½	04761	5.3	\$70.40
------	-------	-----	----------------



Part No. NH 25
Figure Five Double Fixture Fitting

2	12027	7.0	\$68.40
3	10222	10.5	170.20
3x2x3x3 Reducing	12028	10.7	164.90 N
4	10223	22.5	277.00
4x2x4x4 Reducing	12029	19.8	263.90 N

Part No.	Size	*UPC# 611942-	Weight	List Price Each
----------	------	------------------	--------	--------------------



Part No. EZS 6*
Figure Six
(Double, Left Hand or Right Hand;
Designed for use below the floor;
Double fitting has a baffle.)

EZS 6D	3x2	12086	13.0	\$295.00 N
EZS 6D	4x2	12089	23.1	309.50 N

EZS 6L	3x2	12084	11.4	155.80 N
EZS 6L	4x2	12087	18.0	177.30 N

EZS 6R	3x2	12085	11.4	155.80 N
EZS 6R	4x2	12088	18.0	177.30 N



Part No. EZS 8*
Figure Eight
(Double, Left Hand or Right Hand;
Designed for use below the floor;
Double fitting has a baffle.)

EZS 8D	3x2	12092	13.0	\$452.80 N
--------	-----	-------	------	-------------------

EZS 8L	3x2	12090	12.5	240.70 N
EZS 8L	4x2	12093	19.8	333.70 N

EZS 8R	3x2	12091	12.5	240.70 N
EZS 8R	4x2	12094	19.8	333.70 N

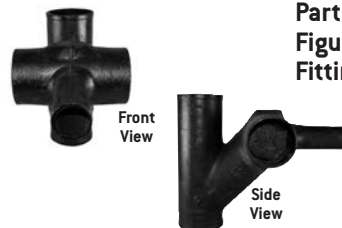

Part No. EZS 8A
Figure Eight Double Fixture
Fitting, Extended

EZS 8A	4x2	12031	23.4	\$452.80 N
--------	-----	-------	------	-------------------

N = Non-stock item; Contact customer service for availability.

***When ordering please specify Double, Left or Right.**

Part No.	Size	M Inlet	B Inlet	*UPC# 611942-	Weight	List Price Each	Part No.	Size	M Inlet	B Inlet	*UPC# 611942-	Weight	List Price Each
----------	------	---------	---------	---------------	--------	-----------------	----------	------	---------	---------	---------------	--------	-----------------

Part No. EZS 100*
16" Closet Fitting with 2" Inlets
(Double, Left Hand or Right Hand; Designed for use below the floor.)

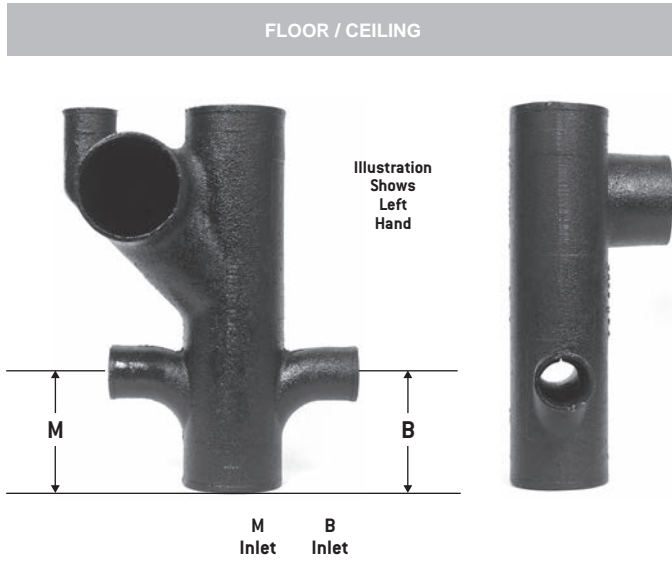

		M Inlet	B Inlet			
EZS 100D	4x16	5	5	04505	22.0	\$288.60 N
EZS 100L	4x16	5	5	04497	18.0	244.90 N
EZS 100R	4x16	5	5	04489	21.1	244.90 N

Part No. EZS 400*
30" Closet Fitting with or without 2" Inlets
(Double, Left Hand or Right Hand; Designed for use in the floor.)

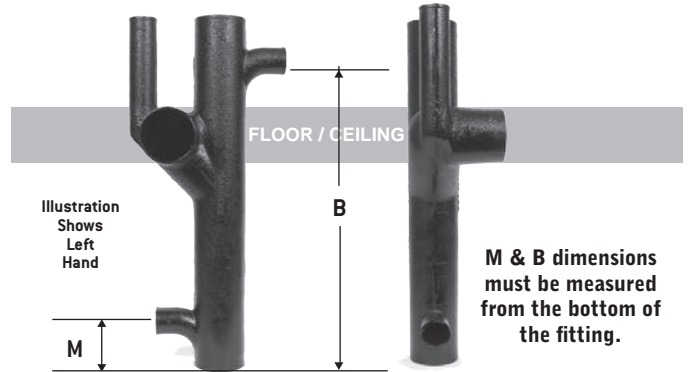

		M Inlet	B Inlet			
EZS 400D	4x30	0	0	04630	29.3	\$469.00 N
EZS 400D	4x30	0	6½	04628	36.4	556.80 N
EZS 400D	4x30	0	12	04627	39.6	556.80 N
EZS 400D	4x30	4	0	04622	38.0	469.00 N
EZS 400D	4x30	6½	0	04614	35.6	469.00 N
EZS 400D	4x30	6½	26½	04607	38.9	469.00 N
EZS 400D	4x30	12	0	04606	35.7	556.80 N
EZS 400D	4x30	12	26½	04599	38.0	556.80 N
EZS 400L	4x30	0	0	04598	34.0	429.90 N
EZS 400L	4x30	0	6½	04596	34.2	429.90 N
EZS 400L	4x30	0	12	04595	37.8	429.90 N
EZS 400L	4x30	0	26½	04591	34.3	429.90 N
EZS 400L	4x30	4	0	04590	34.0	429.90 N
EZS 400L	4x30	4	26½	04583	34.0	510.70 N
EZS 400L	4x30	6½	0	04582	33.1	429.90 N
EZS 400L	4x30	6½	6½	04580	34.0	510.70 N
EZS 400L	4x30	6½	26½	04575	36.8	510.70 N
EZS 400L	4x30	12	0	04574	31.0	429.90 N
EZS 400L	4x30	12	26½	04567	30.0	510.70 N
EZS 400R	4x30	0	0	04566	32.9	429.90 N
EZS 400R	4x30	0	6½	04564	34.5	429.90 N
EZS 400R	4x30	0	12	04563	37.1	429.90 N
EZS 400R	4x30	0	26½	04559	33.8	429.90 N
EZS 400R	4x30	4	0	04558	34.0	429.90 N
EZS 400R	4x30	4	26½	04551	28.9	510.70 N
EZS 400R	4x30	6½	0	04550	33.9	429.90 N
EZS 400R	4x30	6½	6½	04548	35.4	510.70 N
EZS 400R	4x30	6½	26½	04543	35.4	510.70 N
EZS 400R	4x30	12	0	04542	31.0	429.90 N
EZS 400R	4x30	12	26½	04536	28.5	510.70 N

*When ordering please specify Double, Left or Right.

N = Non-stock item; Contact customer service for availability.

Part No.	Size	A Inlet	B Inlet	*UPC# 611942-	Weight	List Price Each	Part No.	Size	A Inlet	B Inlet	*UPC# 611942-	Weight	List Price Each
----------	------	---------	---------	---------------	--------	-----------------	----------	------	---------	---------	---------------	--------	-----------------

Part No. EZS 700

Threaded Starter Fitting with or without 2" No-Hub Inlets
(Double, Left Hand or Right Hand; Designed for use above the floor with back-outlet water closets; Double starter fittings have a baffle.)



Illustration Shows Left Hand



Illustration Shows Double

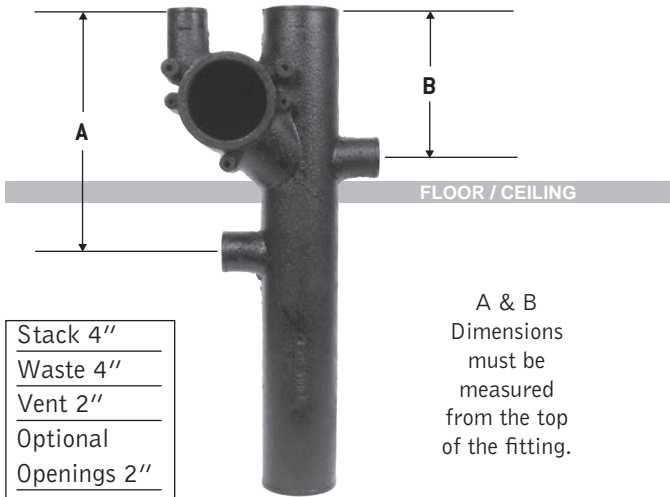

A & B Dimensions must be measured from the top of the fitting.

	A Inlet	B Inlet				
EZS 700D [‡] 4x28	0	0	04948	40.0	\$585.00	
EZS 700D [‡] 4x28	0	8½	04936	42.0	585.00	
EZS 700D [‡] 4x28	23½	8½	04738	42.0	585.00 N	
EZS 700L 4x28	0	0	04941	34.6	460.20	
EZS 700L 4x28	0	8½	04937	35.7	460.20	
EZS 700L 4x28	14	8½	04734	36.3	678.60 N	
EZS 700L 4x28	23½	8½	04731	32.0	460.20 N	
EZS 700R 4x28	0	0	04939	30.0	460.20	
EZS 700R 4x28	0	8½	04938	34.0	460.20	
EZS 700R 4x28	14	8½	04727	35.3	678.60 N	
EZS 700R 4x28	23½	8½	04730	32.0	460.20 N	

Note: Trim package not included in price of fitting. See trim packages on page 14.

[‡] Double starter fitting has a baffle.

N = Non-stock item; Contact customer service for availability.

Part No. EZS 800

Threaded Starter Fitting with or without 2" No-Hub Inlets
(Double, Left Hand or Right Hand; Designed for use above the floor with back-outlet water closets; Double starter fittings have a baffle.)



Illustration Shows Right Hand



Illustration Shows Double

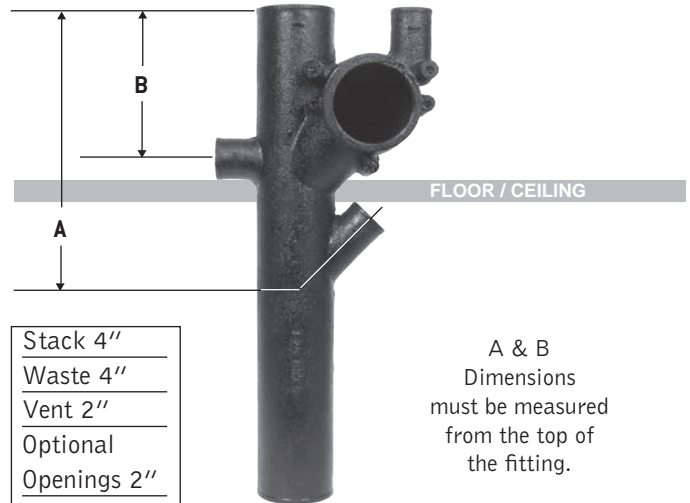

A & B Dimensions must be measured from the top of the fitting.

	A Inlet	B Inlet				
EZS 800D [‡] 4x28	16	0	04746	42.0	\$585.00	
EZS 800D [‡] 4x28	16	8½	04745	42.0	694.40	
EZS 800L 4x28	16	0	04772	35.4	460.20	
EZS 800L 4x28	16	8½	04742	36.3	460.20	
EZS 800R 4x28	16	0	04773	35.6	460.20	
EZS 800R 4x28	16	8½	04744	35.3	460.20	

Note: Trim package not included in price of fitting. See trim packages on page 14.

[‡] Double starter fitting has a baffle.

Part No.	Size	A Inlet	B Inlet	*UPC# 611942-	Weight	List Price Each	Part No.	Size	A Inlet	B Inlet	*UPC# 611942-	Weight	List Price Each
----------	------	---------	---------	---------------	--------	-----------------	----------	------	---------	---------	---------------	--------	-----------------

Part No. EZS 710

No-Hub Starter Fitting with or without 2" No-Hub Inlets
(Double, Left Hand or Right Hand; Designed for use above the floor with back-outlet water closets; Double starter fittings have a baffle.)

Top View

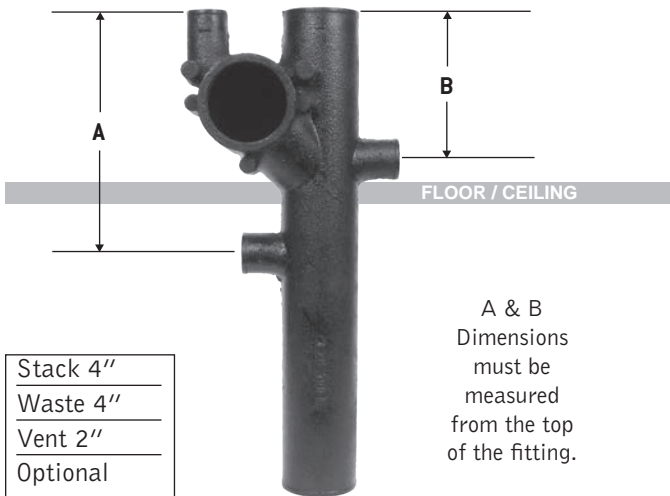

Illustration Shows Left Hand

Top View



Illustration Shows Double



A & B Dimensions must be measured from the top of the fitting.

- Stack 4"
- Waste 4"
- Vent 2"
- Optional Openings 2"
- Length 28"

	A Inlet	B Inlet				
EZS 710D [‡] 4x28	0	0	11032	40.0	\$585.00	
EZS 710D [‡] 4x28	0	8½	11033	42.0	585.00	
EZS 710D [‡] 4x28	23½	8½	11034	42.0	726.10 N	
EZS 710L 4x28	0	0	11028	34.6	460.20	
EZS 710L 4x28	0	8½	11029	26.9	460.20	
EZS 710L 4x28	14	8½	11030	36.3	571.60 N	
EZS 710L 4x28	23½	8½	11031	37.6	571.60 N	
EZS 710R 4x28	0	0	11024	34.0	460.20	
EZS 710R 4x28	0	8½	11025	34.0	460.20	
EZS 710R 4x28	14	8½	11026	35.3	571.60 N	
EZS 710R 4x28	23½	8½	11027	36.7	571.60 N	

Note: Not designed for use with trim package.
‡ Double starter fitting has a baffle.

N = Non-stock item; Contact customer service for availability.

Part No. EZS 810

No-Hub Starter Fitting with or without 2" No-Hub Inlets
(Double, Left Hand or Right Hand; Designed for use above the floor with back-outlet water closets; Double starter fittings have a baffle.)

Top View

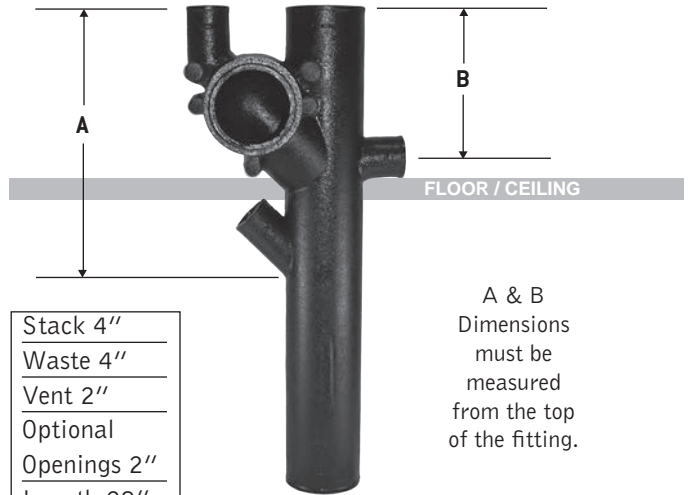

Illustration Shows Left Hand

Top View



Illustration Shows Double



A & B Dimensions must be measured from the top of the fitting.

- Stack 4"
- Waste 4"
- Vent 2"
- Optional Openings 2"
- Length 28"

	A Inlet	B Inlet			
EZS 810D [‡] 4x28	16	0	11022	42.0	\$585.00
EZS 810D [‡] 4x28	16	8½	11023	44.0	585.00
EZS 810L 4x28	16	0	11020	35.4	460.20
EZS 810L 4x28	16	8½	11021	36.3	460.20
EZS 810R 4x28	16	0	11018	36.6	460.20
EZS 810R 4x28	16	8½	11019	35.3	460.20

Note: Not designed for use with trim package.
‡ Double starter fitting has a baffle.

*UPC#	Weight	List Price	*UPC#	Weight	List Price
611942-		Each	611942-		Each

Part No. EZS 22
Trim Package: Support Frame Assembly
(Weight capacity for the EZS 22 Support Frame is 500 pounds maximum.)

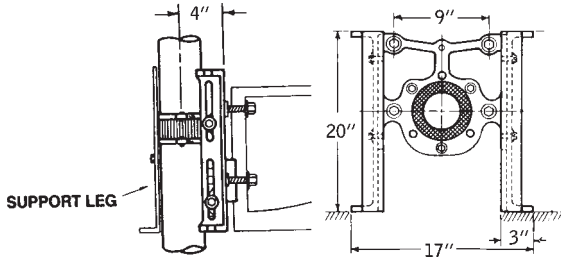

- 1—FRAME
- 1—LEFT LEG
- 1—RIGHT LEG
- 1—SUPPORT LEG (used for single only)
- 5— $\frac{1}{2}$ " x $\frac{1}{4}$ " BOLTS
- 5— $\frac{1}{2}$ " FLAT WASHERS

04757	24.0	\$241.30
-------	------	-----------------

Part No. EZS 23
Trim Package: Floor-Mounted Back-Outlet Assembly
(Note: Not to be used with Part No. EZS 22 Support Frame Assembly)

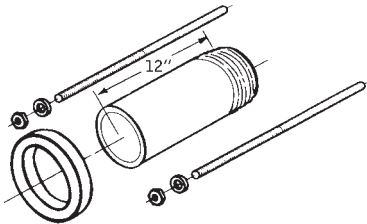

- 1—4" PVC Sch. 80 NIPPLE with TEST CAP
- 1—BOWL GASKET
- 2— $\frac{5}{16}$ " x 12" RODS
- 2— $\frac{5}{16}$ " HEX NUTS
- 2— $\frac{5}{16}$ " FLAT WASHERS
- 2— $\frac{5}{16}$ " CAP NUTS

04759	2.8	\$108.50
-------	-----	-----------------

Part No. EZS 24
Trim Package: Wall-Hung Back-Outlet Assembly
(To be used with Part No. EZS 22 Support Frame Assembly)

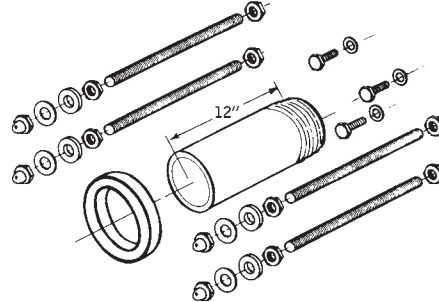

- 1—4" PVC Sch. 80 NIPPLE with TEST CAP
- 1—BOWL GASKET
- 4— $\frac{5}{8}$ " x 12" RODS
- 4— $\frac{5}{8}$ " CHROME CAP NUTS
- 8— $\frac{5}{8}$ " JAM NUTS
- 4— $\frac{5}{8}$ " FLAT WASHERS
- 4— $\frac{5}{8}$ " FIBER WASHERS
- 3— $\frac{3}{8}$ " x $1\frac{1}{2}$ " BOLTS FOR FACEPLATE
- 3— $\frac{3}{8}$ " FLAT WASHERS
- 4— $\frac{5}{8}$ " STAR WASHERS

04758	2.8	\$216.40
-------	-----	-----------------

Exploded View of Support Assembly Hardware

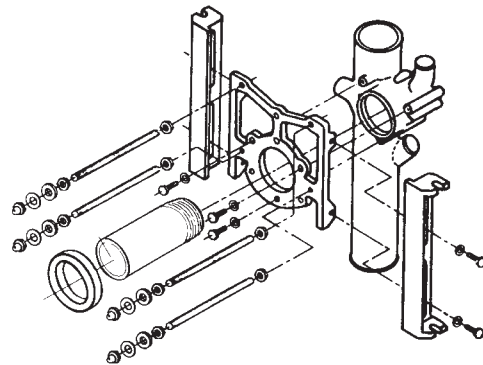

EZS 22 and EZS 24 Assemblies Illustrated

Note: Dimensions and tolerances for No-Hub pipe and fittings are published in Charlotte Pipe’s Cast Iron Dimensional Catalog and also Charlotte Pipe’s Cast Iron Technical Manual.

TEN FOOT PIPE BUNDLES NO-HUB PIPE

Size	Pieces	Weight	Height
1½ x 10	72	2052	12"
2 x 10	54	1906	11"
3 x 10	36	1944	14"
4 x 10	27	2052	17"
5 x 10	24	2342	20"
6 x 10	18	2120	23"
8 x 10	8	1367	22"
10 x 10	6	1528	26"
12 x 10	6	1908	29"
15 x 10	2	985	19"

Weights are approximate and are for shipping purposes only.

All products manufactured by Charlotte Pipe and Foundry Company are proudly made in the U.S.A.

**CHARLOTTE® CAST IRON SOIL PIPE AND FITTINGS
SPECIFICATIONS**

This is to certify that products manufactured by Charlotte Pipe and Foundry, Cast Iron Division, are manufactured in the United States and conform to the following standards:

NO-HUB (HUBLESS) PIPE AND FITTINGS

All cast iron soil pipe and fittings shall be marked with the collective trademark of the Cast Iron Soil Pipe Institute (CISPI).
CISPI Standard 301
ASTM A 888
Listed by NSF® International to the UP Code
ISO 9001:2015 Certified

NO-HUB (HUBLESS) COUPLINGS

Cast Iron Soil Pipe Institute Standard No. 310
ASTM C 1277
Certified by NSF® International

NO-HUB (HUBLESS) HEAVY DUTY COUPLINGS

ASTM C 1540
Factory Mutual 1680

Charlotte Pipe products are manufactured to the applicable ASTM standard. Charlotte Pipe and Foundry cannot accept responsibility for the performance, dimensional accuracy, or compatibility of pipe, fittings, gaskets, or couplings not manufactured or sold by Charlotte Pipe and Foundry.

Terms of Sale

We are pleased to present our list price schedule for use in ordering Charlotte Pipe and Foundry Company® (Charlotte Pipe®) Products. To determine current prices, please refer to the prices shown in the list price schedule. You may seek further clarification from our local manufacturers’ agent or the factory sales office. **All prices in list price schedules are subject to change without notice. Orders will be billed at the prevailing price at the time of shipment.** All quotations, sales, and agreements are subject to strikes, accidents, transportation failures or other causes beyond our control. Any tax, effective under present or future laws, shall be added as an extra to the price of the product and shall be paid by the purchaser. **Possession of product information or list price schedules shall not be construed as an offer to sell the product listed.**

ARBITRATION: CHARLOTTE PIPE AND CUSTOMER AGREE THAT ANY DISPUTE, CLAIM OR CONTROVERSY OF ANY NATURE, WHETHER BASED ON CONTRACT, TORT, STATUTE, OR ANY OTHER LEGAL OR EQUITABLE THEORY, ARISING OUT OF OR RELATED TO THE SALE OF PRODUCTS FROM CHARLOTTE PIPE TO CUSTOMER SHALL BE RESOLVED THROUGH BINDING ARBITRATION ADMINISTERED PURSUANT TO TITLE 9 OF THE U.S. CODE BY JAMS UNDER ITS COMPREHENSIVE ARBITRATION RULES AND PROCEDURES, AND JUDGMENT ON THE AWARD ENTERED BY THE ARBITRATOR(S) MAY BE ENTERED BY ANY COURT HAVING JURISDICTION THEREOF. EITHER PARTY MAY APPLY TO THE ARBITRATOR SEEKING INJUNCTIVE RELIEF UNTIL THE ARBITRATION AWARD IS ENTERED OR THE MATTER IS RESOLVED. EITHER PARTY ALSO MAY, WITHOUT WAIVING ANY REMEDY AVAILABLE TO IT, SEEK FROM ANY COURT OF COMPETENT JURISDICTION ANY PROVISIONAL OR INTERIM RELIEF THAT IS NECESSARY TO PROTECT ITS RIGHTS PENDING THE ARBITRATOR(S)’ DETERMINATION OF THE MERITS OF THE DISPUTE, CLAIM OR CONTROVERSY.

CLASS ACTION WAIVER: CHARLOTTE PIPE AND CUSTOMER AGREE THAT THERE WILL BE NO RIGHT OR AUTHORITY FOR ANY CLAIM, DISPUTE AND/OR CONTROVERSY COVERED UNDER THE PARTIES’ AGREEMENT TO ARBITRATE TO BE BROUGHT, HEARD, OR ARBITRATED AS A CLASS ACTION AND/OR COLLECTIVE ACTION AND/OR REPRESENTATIVE ACTION. NOR SHALL THE ARBITRATOR(S) HAVE ANY AUTHORITY TO HEAR OR ARBITRATE ANY SUCH CLASS AND/OR COLLECTIVE ACTION AND/OR REPRESENTATIVE ACTION. REGARDLESS OF ANYTHING ELSE IN THESE TERMS AND CONDITIONS OR BY VIRTUE OF ANY ARBITRATION RULES OR PROCEDURES OF THE AAA THAT NOW APPLY OR ANY AMENDMENTS AND/OR MODIFICATIONS TO THOSE RULES, THE ENFORCEABILITY AND VALIDITY OF THIS CLASS ACTION WAIVER MAY BE DETERMINED ONLY BY A COURT AND NOT BY AN ARBITRATOR. NOTWITHSTANDING ANY OTHER CLAUSE CONTAINED IN THESE TERMS AND CONDITIONS, THIS CLAUSE ENTITLED CLASS ACTION WAIVER SHALL NOT BE SEVERABLE FROM THESE TERMS AND CONDITIONS IN ANY CASE IN WHICH THE DISPUTE TO BE ARBITRATED IS BROUGHT AS A CLASS AND/OR COLLECTIVE ACTION. THIS CLASS ACTION WAIVER AND THE AGREEMENT TO ARBITRATE ANY CLAIM, DISPUTE OR CONTROVERSY PRECLUDES CUSTOMER FROM LITIGATING IN COURT OR ARBITRATING ANY CLAIMS AGAINST CHARLOTTE PIPE AS A REPRESENTATIVE OR MEMBER OF A CLASS OR IN A PRIVATE ATTORNEY GENERAL CAPACITY.

Charlotte Pipe and Charlotte are registered trademarks of Charlotte Pipe and Foundry Company.

LIMITED WARRANTY

Charlotte Pipe and Foundry Company® (Charlotte Pipe®) Products are warranted to be free from manufacturing defects and to conform to currently applicable ASTM standards for a period of five (5) years from date of delivery. Buyer's remedy for breach of this warranty is limited to replacement of, or credit for, the defective product. This warranty excludes any expense for removal or reinstallation of any defective product and any other incidental, consequential, or punitive damages. **This limited warranty is the only warranty made by seller and is expressly in lieu of all other warranties, express and implied, including any warranties of merchantability and fitness for a particular purpose.** No statement, conduct or description by Charlotte Pipe or its representative, in addition to or beyond this Limited Warranty, shall constitute a warranty. This Limited Warranty may only be modified in writing signed by an officer of Charlotte Pipe.

This Limited Warranty will not apply if:

- 1) The Products are used for purposes other than their intended purpose as defined by local plumbing and building codes, and the applicable ASTM standard.
 - 2) The Products are not installed in good and workmanlike manner consistent with normal industry standards; installed in compliance with the latest instructions published by Charlotte Pipe and good plumbing practices; and installed in conformance with all applicable plumbing, fire and building code requirements.
 - 3) This limited warranty does not apply when the products of Charlotte Pipe are used with the products of other manufacturers that do not meet the applicable ASTM or CISPI standards or that are not marked in a manner to indicate the entity that manufactured them.
 - 4) In hubless cast iron installations, this warranty will not apply if products are joined with unshielded hubless couplings. Charlotte Pipe requires that its hubless cast iron pipe and fittings be joined only with shielded hubless couplings manufactured in accordance with CISPI 310, ASTM C 1277 and certified by NSF® International or with Heavy Duty Couplings meeting ASTM C 1540.
 - 5) The Products fail due to defects or deficiencies in design, engineering, or installation of the piping system of which they are a part.
 - 6) The Products have been the subject of modification; misuse; misapplication; improper maintenance or repair; damage caused by the fault or negligence of anyone other than Charlotte Pipe; or any other act or event beyond the control of Charlotte Pipe.
- 7) The Products fail due to the freezing of water in the Products.
 - 8) The Products fail due to contact with chemical agents, fire stopping materials, thread sealant, plasticized vinyl products, or other aggressive chemical agents that are not compatible.
 - 9) Pipe outlets, sound attenuation systems or other devices are permanently attached to the surface of Charlotte® PVC, ABS or CPVC products with solvent cement or adhesive glue.

Charlotte Pipe products are manufactured to the applicable ASTM or CISPI standard. Charlotte Pipe and Foundry **cannot** accept responsibility for the performance, dimensional accuracy, or compatibility of pipe, fittings, gaskets, or couplings not manufactured or sold by Charlotte Pipe and Foundry.

Any Charlotte Pipe products alleged to be defective **must** be made available to Charlotte Pipe at the following address for verification, inspection and determination of cause:

Charlotte Pipe and Foundry Company
Attention: Technical Services
2109 Randolph Road
Charlotte, North Carolina 28207

Purchaser must obtain a return materials authorization and instructions for return shipment to Charlotte Pipe of any product claimed defective or shipped in error.

Any Charlotte Pipe product **proved** to be defective in manufacture will be replaced F.O.B. point of original delivery, or credit will be issued, at the discretion of Charlotte Pipe.

4/24/15

! WARNING

Testing with or use of compressed air or gas in PVC / ABS / CPVC / Cast Iron pipe or fittings can result in explosive failures and cause severe injury or death.

AIR/GAS



- NEVER test with or transport/store compressed air or gas in PVC / ABS / CPVC / Cast Iron pipe or fittings.
- NEVER test PVC / ABS / CPVC / Cast Iron pipe or fittings with compressed air or gas, or air over water boosters.
- ONLY use PVC / ABS / CPVC / Cast Iron pipe or fittings for water or approved chemicals.
- Refer to warnings on PPFA's website and ASTM D 1785.

Charlotte, Charlotte Pipe and "You can't beat the system" are registered trademarks of Charlotte Pipe and Foundry Company.

All products manufactured by Charlotte Pipe and Foundry Company are proudly made in the U.S.A.

You can't beat the system.®